

**ferrum**

**BEST IN CLASS CENTRIFUGE TECHNOLOGY  
FULFILLS YOUR NEEDS**



# SUCCESS NEEDS TARGETS

## OPTIMIZING PRODUCTION AND REDUCING COSTS

Centrifuges for solid-liquid separation process a wide variety of materials. However, the economic objective behind the processing procedure is the same everywhere: to keep production high without any loss of quality and to do so at low cost in the long term.



### INCREASING PRODUCTION

---

Sometimes, the right thing is more of the same. Increasing production not only leads to greater output, but often also to greater efficiency. This calls for production facilities that provide a sound basis for increasing output.



### OPTIMIZING PROCESSES

---

The weakest link in the chain determines the pace and the output. Optimizing means addressing this fact and adjusting all links in the chain accordingly. The alternative, of course, is to have no weak links in the chain.



### REDUCING COSTS IN THE LONG TERM

---

Anyone who invests for the long term rightly expects costs to be low over the entire useful life of the investment. However, this is only the case if the investment made is also sustainable and delivers what it promises over the long term.



### MAINTAINING QUALITY

---

Increasing production, optimizing processes and reducing costs? By all means, but this should not be at the expense of quality. After all, maintaining quality also means securing sales in the long term.

A man with short brown hair and a light beard, wearing a blue and grey work jacket with a 'FERRUM' patch on the chest, stands with his arms crossed in a factory setting. The background shows blurred industrial equipment and shelves.

# SPECIFICALLY IMPLEMENTING WHAT YOU NEED

## **FERRUM - OUR PREMIUM CONCEPT BRINGS “SWISSNESS” TO THE WHOLE WORLD**

---

Ferrum machines are known worldwide for their reliability. Over 100 years of experience go into every machine. And you can see that in our machinery: top quality and advanced technology lead to needs-based and sustainable solutions. That is why many of the world's largest companies put their trust in our centrifuges. They all also appreciate our global service and fast spare parts delivery.

## **FERRUM PROCESS SYSTEMS - CENTRIFUGE TECHNOLOGY**

---

We are one of the world's leading manufacturers of industrial centrifuges for solid-liquid separation. Our many customers from different industries vouch for the quality and variety of our solutions for dynamic separation processes. If you work with us to perfectly integrate a Ferrum centrifuge into your process, you'll receive a promise that pays dividends: a worthwhile investment in the long term that does not neglect quality, even when under high pressure.

# CENTRIFUGE TECHNOLOGY

## OUR MISSION



“ With your benefit in mind we provide you best in class solutions based on our proven competencies and comprehensive experiences. ”

KARL BAUMANN  
CEO FERRUM PROCESS SYSTEMS

Our primary objective is to maintain our position as one of the leading manufacturers and suppliers of high-quality, custom-designed pusher and scraper centrifuges. We achieve this through a unique combination of experience, precision quality, a high degree of innovation and close customer contact.

### YOUR BENEFITS

---

- + One of the global leading suppliers of industrial centrifuges
- + Custom built, intelligent solutions
- + Environmentally sustainable
- + Excellent service support

# EXPERTISE FROM A SINGLE SOURCE

Ferrum offers you customer-specific complete systems from a single source and, with its unique vertical range of manufacture, guarantees the highest quality without interface problems. We build our centrifuges and automation systems in-house.

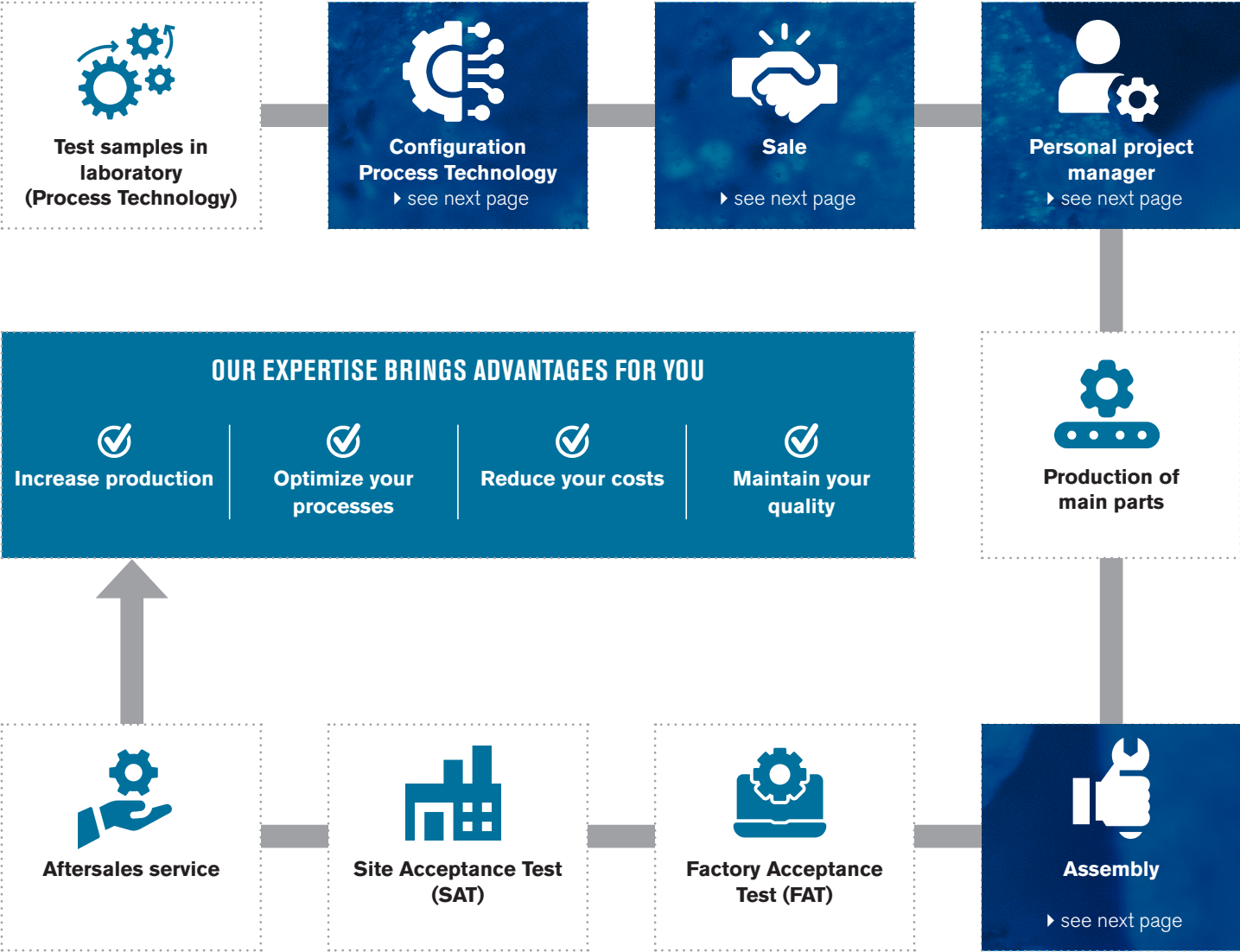

# YOUR BENEFIT IS OUR COMPETENCE

Use our expertise to your advantage. You can rely on us to always bring out the maximum in quality, efficiency and innovation at every level.

Thanks to our modern tools for research and design, we have the right answer to your high expectations: high-level process solutions.

We have invested years in the development of centrifuge automation systems. These proven hardware and software modules serve as the basis, and are supplemented with customized elements.



## PROCESS TECHNOLOGY

### Process orientated

Our process engineers always take your entire production process into account, as this is the only way that we can meet your specific requirements and include your peripheral components in the development.

- + Tests in our laboratories
- + Tests at your premises
- + Commissioning of new systems
- + Optimization of existing systems



## **SALES**

### **Individual consultation**

Our representatives and area sales managers on site want to know your exact needs and requirements, so that we can offer you the best possible solutions and conditions.

- + **On site at your production location**
- + **Experienced and competent sales staff**
- + **Worldwide network**
- + **Tailor-made solutions**
- + **Short response times**



## **PROJECT MANAGEMENT**

### **Customised**

For us, project management always means making a comprehensive and personal promise. And, from the start of the project to commissioning, your project manager will ensure that this promise is kept.

- + **Personal contact**
- + **Individual support**
- + **Short communication channels**
- + **Experienced and motivated team**



## **ASSEMBLY SHOP**

### **Precise and efficient**

Our production and development teams work closely together to guarantee high-quality and innovative centrifuges. The efficient lean assembly technology also ensures short delivery times.

- + **Lean assembly processes**
- + **Continuous staff training**
- + **Ongoing monitoring and benchmarking to achieve the highest standards**

# APPLICATIONS

## OPERATION RANGES

Each type of Ferrum centrifuge has an optimal operating range with regards to particle size and solids concentration.

For larger particles and higher solid concentrations, a continuously operating pusher centrifuge can be considered.

For small particles and low solid concentrations a discontinuously operating scraper centrifuge should be considered.

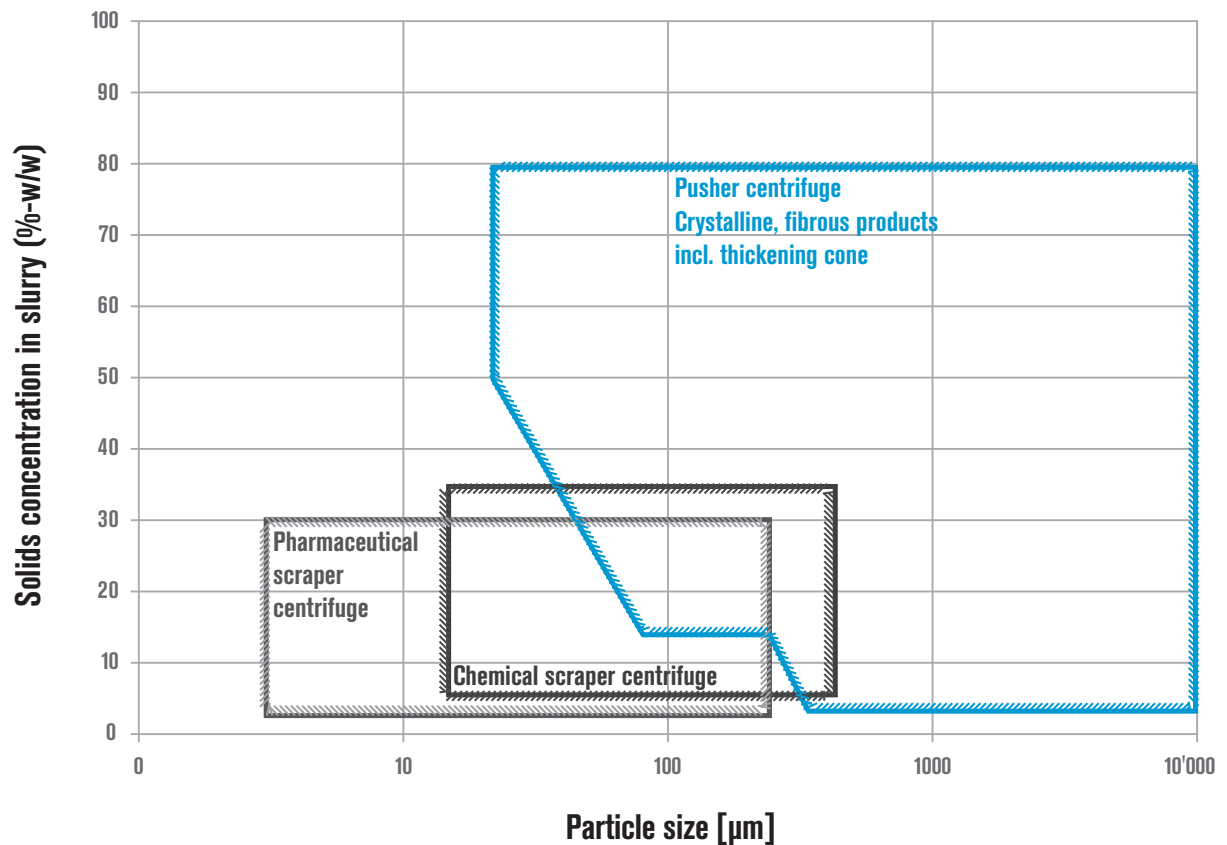





Our centrifuges for mineral processing significantly increase the throughput when separating your valuable components. Thanks to their robust and reliable design and wear- and corrosion-resistant materials, Ferrum centrifuges guarantee long and trouble-free operation. The ingenious technology meets the highest demands to increase the separation efficiency of your mineral materials.

## P60 – P120

### Pusher Centrifuge

Based on the very successful Sulzer Escher Wyss design, Ferrum has improved and developed these pusher centrifuges consistently and according to the latest requirements and guidelines. Ferrum pusher centrifuges P-60 to P-120 guarantee best solid-liquid separation with high and constant product quality.

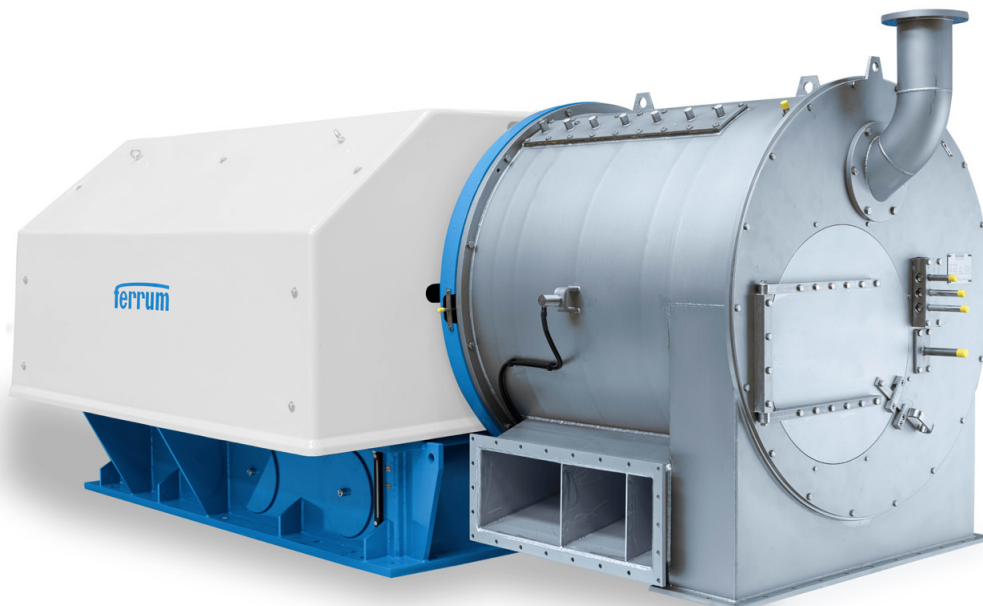

## APPLICATIONS

### + Mining

- Barite recovery
- Drilling mud
- Gold, Silver, Lead, Zinc,
- Nickel, Copper, Platinum
- Kaolin, Calcium carbonate, Titanium dioxide, Barite, Zinc sulphate, Aluminium hydroxide
- Potassium chloride from crystallization or flotation
- Rock phosphate
- Rock salt/Sea salt
- Sludge

## CENTRIFUGES FOR MINERAL PROCESSING

### + Pusher Centrifuges

- PM-23
- P-32 – P-50
- P-60 – P-120

### + Horizontal Basket Centrifuges

- HCZ 1000 – 1600

### + Vertical Basket Centrifuges

- VBC-W 1000 – 1600
- VBC-S 1000 – 1250



ALL ABOUT CENTRIFUGES FOR  
MINERAL PROCESSING

► [ferrum.net/mineral-processing](https://ferrum.net/mineral-processing)

# CHEMICALS

Our chemical centrifuges are designed for numerous chemical processes in various applications. Trouble-free operation under maximum performance and high mechanical stress guarantees continuous operation with high economic value added. Thanks to the constant availability of spare and wear parts, you keep the productivity of your chemical centrifuges high and your investment and operating costs low.



## APPLICATIONS

### + Chlorates

- Sodium chlorate
- Potassium chlorate

### + Chlorides

- Sodium chloride
- Potassium chloride
- Ammonium chloride
- Lithium chloride
- Sodium Dichloroisocyanurate

### + Fibrous Products

- Nitrocellulose
- CMC

### + Intermediate Products

- Sodium bicarbonate crude
- Sodium carbonate monohydrate

### + Nitrates

- Sodium nitrate
- Potassium nitrate
- Lysine

### + Phosphates

- MKP, MAP

### + Sulphates

- Copper sulphate pentahydrate
- Iron sulphate heptahydrate
- Magnesium sulphate heptahydrate
- Nickel sulphate dihydrate
- Nickel sulphate hexahydrate
- Zinc sulphate
- Zinc sulphate monohydrate
- Zinc sulphate heptahydrate
- Potassium sulphate
- Lithium sulphate
- Sodium sulphate anhydride
- Sodium sulphate decahydrate
- Ammonium sulphate

### + Urea

- Different processes

### + Various

- Calcium tartrate
- Lithium carbonate
- Lithium hydroxide monohydrate
- Boric acid
- Tartaric acid



### PD-60 – PD-100

#### D-ACT® Pusher Centrifuge

The mechanical basis of the patented D-ACT® pusher centrifuges type PD-60 to PD-100 correspond with the very successful pusher centrifuge type P-60 to P-100. The machines are suitable for products with good dewatering characteristics with medium to large particle size. Due to the kidney-shaped outlet ports the suspension can build a cake and be discharged on both sides of the pusher plate. With this, the D-ACT® pusher centrifuge achieves an up to 80% higher throughput compared to a standard 2-stage pusher centrifuge of the same size with an up to 20% lower specific energy consumption.



### VBC-S 1000–1250

#### Vertical Basket Centrifuge

This new development of the centrifuge type VBC-S (Vertical Bottom discharge Centrifuge – Swivel Open Housing) extends the existing range type VBC.

## CENTRIFUGES FOR CHEMICALS

#### + Pusher Centrifuges

- D-ACT® PD-60 – PD-100
- PM-23
- P-32 – P-50
- P-60 – P-120

#### + Horizontal Basket Centrifuges

- HCZ 1000 – 1600

#### + Vertical Basket Centrifuges

- VBC-W 1000 – 1600
- VBC-S 1000 – 1250
- VGC 1250 – 1600



ALL ABOUT CENTRIFUGES FOR  
CHEMICALS

▶ [ferrum.net/chemicals](https://ferrum.net/chemicals)

# FINE CHEMICAL AND PHARMA

Our centrifuges for the fine chemical and pharmaceutical industry meet all international standards. The optimal design in accordance with the current GMP guidelines guarantees the highest product safety as well as easy handling and maintenance for the operating personnel. Thanks to the modular system, even complex applications with crystal breakage sensitive products or toxic active ingredients (HAPI) are no problem. Use our centrifuges as pilot plants, as laboratory centrifuges, for small-scale production or for continuous operation.

## APPLICATIONS

---

### + Fine Chemicals

- Sodium bicarbonate refined
- Pigments
- Herbicides, insecticides
- Sodium cyanide
- Carbofuran

### + Pharmaceuticals

- Antibiotics, Vitamines
- APIs (all kinds)
- Sodium chloride
- Intermediates

### + Sugar

- Dextrose, Fructose

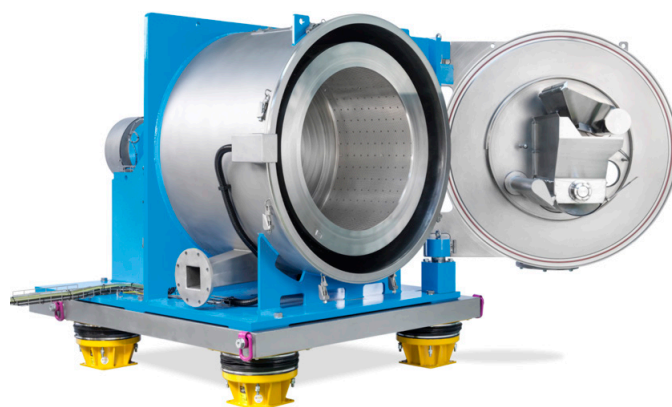

### HCZ 1000 – 1600

#### Horizontal Basket Centrifuge

The horizontal chemical centrifuges were specially designed for high throughputs and continuous operation under the toughest conditions in the chemical and fine chemical industry.



### HPZ 630 – 1250

#### Horizontal Basket Centrifuge

Suitable for pilot plants as well as for production plants in the demanding pharmaceutical industry.

## CENTRIFUGES FOR FINE CHEMICAL AND PHARMA

---

### + Horizontal Basket Centrifuges

- HPZ 630 – 1250
- HCZ 1000 – 1600

### + Vertical Basket Centrifuges

- VBC-W 1000 – 1600
- VBC-S 1000 – 1250
- VGC 1250 – 1600
- DZF 1000 – 1250

### + Pusher Centrifuges

- PM-23
- P-32 – P-50
- P-60 – P-120

### + Special Design Centrifuges



### VTC-I 320

#### Special Design Centrifuge

Specially designed for use in an isolator for highly toxic substances without contamination of the next process step and highest operator safety.



ALL ABOUT CENTRIFUGES FOR FINE CHEMICALS AND PHARMA

► [ferrum.net/pharma](http://ferrum.net/pharma)



Our centrifuges for the petrochemical industry meet the highest safety standards. Thanks to their robust and reliable design, Ferrum centrifuges guarantee long and trouble-free operation. This allows cost-effective production and increases the efficiency of Your plant, not least due to the proven Ferrum technology.



## **P-32 – P-50**

### **Pusher Centrifuge**

The pusher centrifuges P-32 to P-50 are a new development from Ferrum. Thanks to their high-performance hydraulics, the machines have compact dimensions and can be operated with low oil volumes. Ferrum pusher centrifuges P-32 to P-50 guarantee best solid-liquid separation with high and constant product quality

## **APPLICATIONS**

### **+ Basic Products**

- ABS, MBS
- Adipic acid
- Bisphenol A
- Caprolactam
- MEG
- Paraxylene
- Polyethylene
- PP

## **CENTRIFUGES FOR PETROCHEMICALS**

### **+ Pusher Centrifuges**

- PM-23
- P-32 – P-50
- P-60 – P-120

### **+ Vertical Basket Centrifuges**

- VBC-W 1000 – 1600



**ALL ABOUT CENTRIFUGES FOR  
PETROCHEMICALS**

▶ [ferrum.net/petrochemicals](http://ferrum.net/petrochemicals)



Our food centrifuges meet the highest «Food Safety Standards». The construction of our centrifuges guarantees complete and safe cleaning, and the innovative design allows maximum performance of your installation.



## VBC-W 1000–1600

### Vertical Basket Centrifuge

The Vertical Scraper centrifuges VBC (Vertical Bottom discharge Centrifuge) include many application areas in the solid-liquid separation due to the modularity and the comprehensive range of optional equipment.

## APPLICATIONS

### + Basic Products

- Calcium tartrate
- Oils (olive, rapeseed, sunflower, avocado, fish, palm)
- Proteins (fish meal, potato, pea, soy, lupin, rapeseed)
- Sodium bicarbonate refined
- Sodium chloride
- Starch, various
- Tartaric acid

## CENTRIFUGES FOR FOOD

### + Vertical Basket Centrifuges

- VBC-W 1000–1600

### + Pusher Centrifuges

- D-ACT® PD-60–PD-100
- PM-23
- P-32–P-50
- P-60–P-120

### + Horizontal Basket Centrifuges

- HCZ 1000–1600



ALL ABOUT CENTRIFUGES FOR  
FOOD

► [ferrum.net/food](http://ferrum.net/food)



Thanks to Ferrum waste water centrifuges, you can master any solid-liquid separation economically and safely. Thanks to our many years of experience in the field of Zero Liquid Discharge (ZLD), you can solve any challenge in dewatering and filtration.

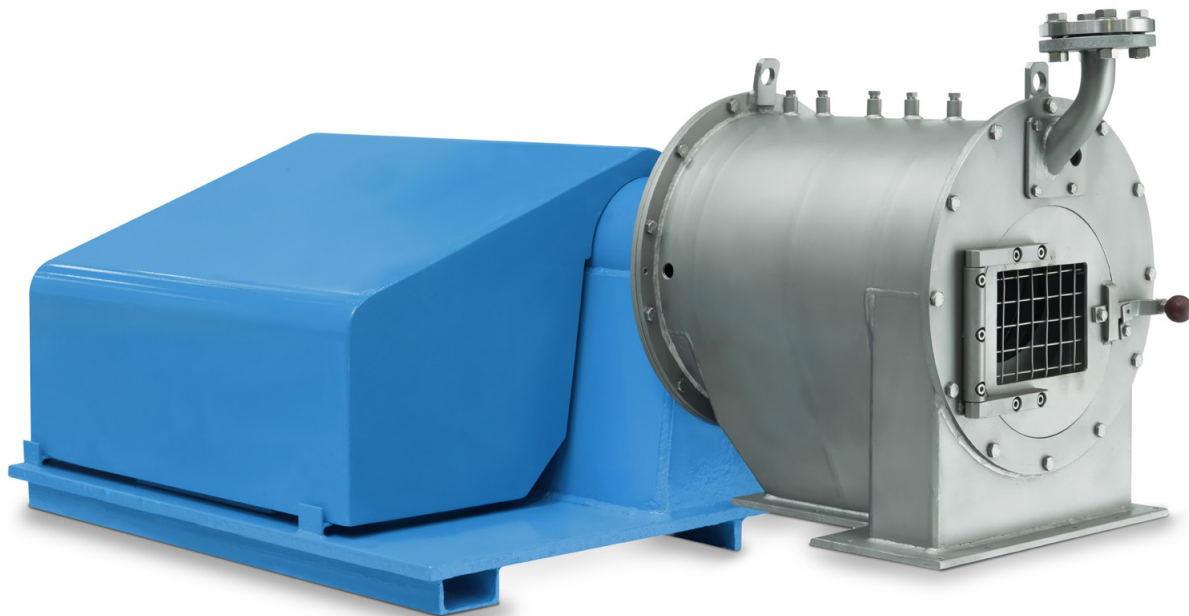

## PM-23

### Pusher Centrifuge

Based on the very successful Sulzer Escher Wyss design, Ferrum has consistently developed this pusher centrifuge further, always in accordance with the latest requirements and guidelines. The PM-23 guarantees best solid-liquid separation with high and constant product quality.

## APPLICATIONS

### + Basic Products

- Sewage
- Sewage sludge, tailings, wash water
- Sodium chloride
- Sodium sulphate

## CENTRIFUGES FOR WASTE WATER

### + Pusher Centrifuges

- PM-23
- P-32 – P-50
- P-60 – P-120

### + Vertical Basket Centrifuges

- VBC-W 1000 – 1600

### + Horizontal Basket Centrifuges

- HCZ 1000 – 1600



ALL ABOUT CENTRIFUGES FOR  
WASTE WATER

► [ferrum.net/waste-water](https://ferrum.net/waste-water)



# ENVIRONMENTAL



We are specialists in manufacturing centrifuges for environmental applications. Ferrum centrifuges are tailored to Your needs and to high-volume production. Our technology allows efficient operation of agro products with lowest residual moisture values worldwide. Cost-effective and safe.



## VGC 1250 – 1600

### Vertical Basket Centrifuge

The Vertical Scraper centrifuges VGC work discontinuously, the solids are discharged vertically downwards. The centrifuge is designed for highest possible availability and reliability. Significant cost advantages are possible through low power consumption and energy regeneration, reduced wash liquid consumption, lower space requirements as well as cleaner operation in a totally enclosed centrifuge system.

## APPLICATIONS

### + Basic Products

- Alum / ferric sludge
- Bioethanol, bio-gas, bio-diesel
- MEG
- PET, PP
- Sewage sludge
- Battery recycling

## CENTRIFUGES FOR ENVIRONMENTAL

### + Vertical Basket Centrifuges

- VBC-W 1000 – 1600

### + Horizontal Basket Centrifuges

- HCZ 1000 – 1600

### + Pusher Centrifuges

- D-ACT®
- PM-23
- P-32 – P-50
- P-60 – P-120



ALL ABOUT CENTRIFUGES FOR ENVIRONMENTAL

► [ferrum.net/environmental](http://ferrum.net/environmental)



# INNOVATION TWO STEPS AHEAD

Our innovations are the result of years of experience combined with current customer needs. Ferrum owns intellectual property on a wide range of products. This includes many applications and process solutions related to centrifuges for solid-liquid separation.

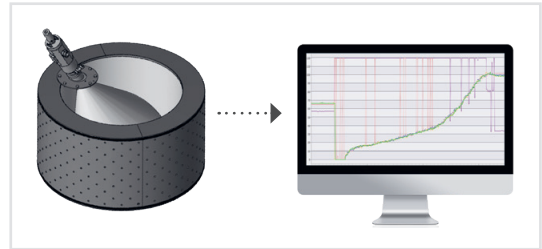

## CONVENIENT PROCESS MONITORING

Optimize your product quality with smart online monitoring and real-time process adjustments using the CentriSense® camera system.

- + **Shorter cycle times, higher yields**
- + **Fast, touchless level control**
- + **100 % process stability – consistency assured**

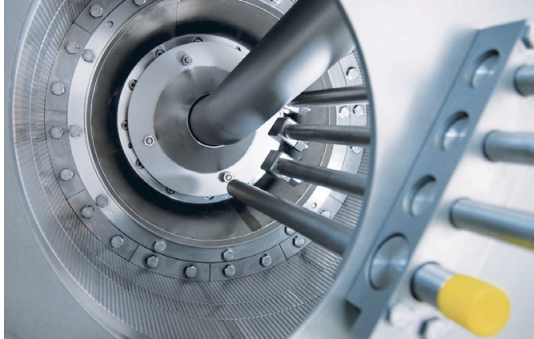

## INTEGRATED THICKENER

Saves space and money by eliminating the need for a separate external pre-thickener for pusher centrifuges. Developed and patented by Ferrum.

- + **No need for separate external pre-thickening**
- + **High efficiency on a small filtration area**
- + **Compensation of fluctuating feed concentrations**
- + **Improved cake formation**
- + **Vibration-free centrifugation**

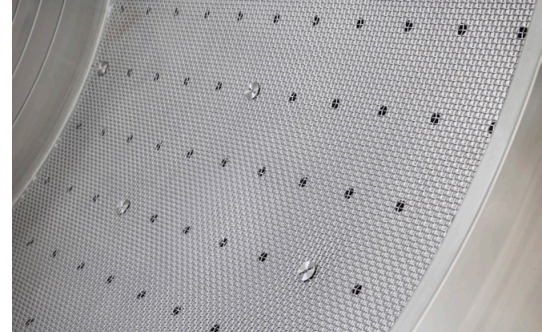

## METALLIC FILTER CLOTHS

A very robust and long service life alternative filter media. Easy installed and available in stainless steel 1.4404 (and others on request).

- + **No fibres in the product**
- + **No changes in the cloth characteristics**
- + **Reduced residual heel**
- + **Complete upgrade kit for many baskets**
- + **Suitable for explosive dust atmospheres**

# SAFETY

## FOR PEOPLE AND MACHINE

Our top priorities are protecting the employees at the machine and not interrupting the production process. From the periphery to the control system, we create the best conditions for achieving this.

### PERIPHERAL ELEMENTS

#### RISK-FREE OPERATION

Achieve the highest process reliability for the most efficient throughput through innovations and proven technologies.

- + **Standard interfaces for trouble-free and straightforward connections of upstream and downstream system elements**
- + **Various valves and butterfly valves**
- + **Flexible connections and flow sight glasses**
- + **Siphons and pressure relief valves**
- + **CIP collectors and valves for the regulation of the CIP cleaning cycles**
- + **Collectors on the centrifuge for the distribution of instrument air, nitrogen and hydraulic oil**
- + **Pilot valve blocks for the control of various system parts**
- + **Dosing devices and agitators for installation below static thickeners**
- + **Hydrocyclones to thicken suspension prior to the centrifuge feed**

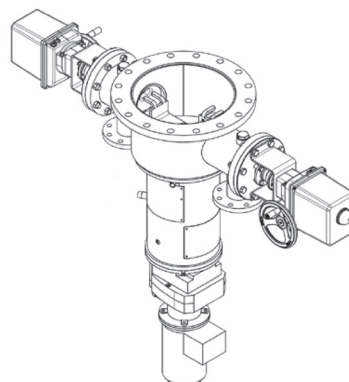
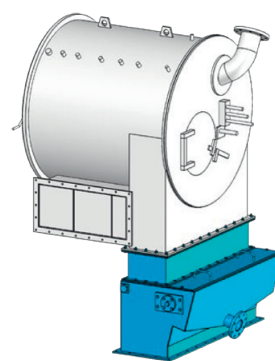

## INERTISATION SYSTEMS

### ABSOLUTE SAFETY

The high demands on the control systems, especially concerning the design of the power components, require the use of safety sensors and safety controllers for centrifuges. Ferrum has many years of experience in this field. We rely on well-known manufacturers with proven components and guarantee a long-life cycle of the control components using current and future-oriented technologies.

- + Safety sensors and safety controllers
- + Proven components from well-known manufacturers
- + Long-life cycle guaranteed

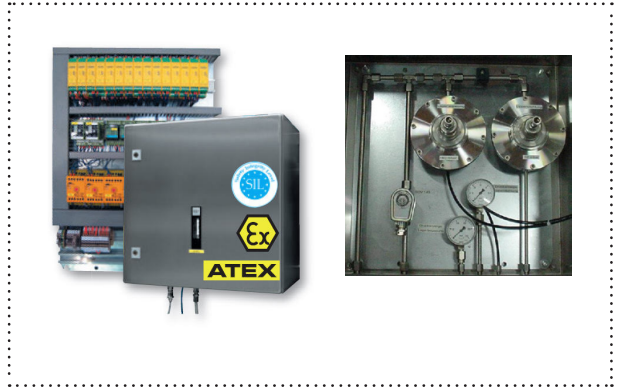

## COMPLETE OVERHAUL

### RELIABLE AND SAFE

Bring your aging Ferrum centrifuge up to date. You will receive optimal advice and support from us to implement your specific requirements. In addition, our decades of centrifuge know-how is at your disposal for minor modifications up to a complete overhaul.

- + Know-how from the original equipment manufacturer
- + Safe operation and fulfillment of all current regulations
- + Short delivery time and 12 month guarantee
- + Complete overhaul
- + Application-specific modifications
- + Detailed documentation

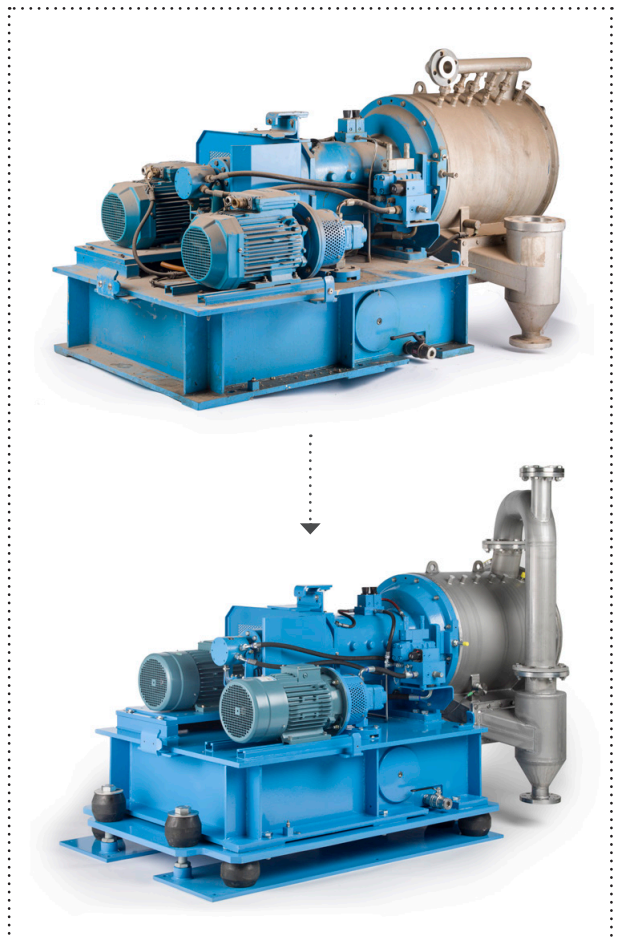

# AFTERSALES SERVICE

## FAST AND RELIABLE

Our experienced consultation teams are there for you worldwide: highly qualified and with a personal touch custom-tailored to your specific needs. Contact us and we will be more than happy to put you in touch with the right contact person.

### SERVICE

A large team of experienced service specialists as well as various service centres are available to our customers worldwide. This ensures we can provide a fast and uncomplicated service.

- + **Prompt and uncomplicated support from our customer service team**
- + **Worldwide service centres**
- + **Maintenance, inspections, maintenance contracts**
- + **Modifications, upgrades and integration of new drive and control systems**
- + **Customer-specific training**

### REMOTE SERVICE

Count on quick and competent support in any situation with Ferrum Remote Service. Our experts will help you ensure quality and safety all day, every day so you achieve your process goals.

- + **Fast, safe commissioning**
- + **Experienced Troubleshooting**
- + **Expert process and systems control**

### SPARE PARTS

You can count on high availability and short delivery times through an extensive and careful stock management of spare parts on our various sites worldwide.

- + **Reliable service worldwide**
- + **Competitive prices**
- + **Top manufacturer quality**
- + **Original parts only**



# FERRUM PROCESS SYSTEMS

## GLOBAL SUPPORT, WHEREVER YOU ARE

- 
- MAIN OFFICES
  - SERVICE CENTRES
  - REPRESENTATIVES

### FERRUM PROCESS SYSTEMS LTD.

Industriestrasse 11  
5503 Schafisheim  
Switzerland  
T +41 62 889 14 11  
[centrifuges@ferrum.net](mailto:centrifuges@ferrum.net)

### HILLER GMBH

Schwalbenholzstrasse 2  
84137 Vilsbiburg  
Germany  
T +49 8741 48 0  
F +49 8741 48 139  
[info@hillerzentr.de](mailto:info@hillerzentr.de)  
[www.hillerzentr.de](http://www.hillerzentr.de)

### FERRUM PROCESS SYSTEMS INC.

11414 W. Park Place  
Suite 202  
Milwaukee, WI 53224  
USA  
T +1 877 933 3778  
F +1 877 711 2329  
[sales@ferrumUS.com](mailto:sales@ferrumUS.com)

### SPOMASZ-WRONKI GRUPA FERRUM SP. Z O.O.

ul. Powstańców Wlkp. 23  
64-510 Wronki  
Poland  
T +48 672 545 169  
[handel@spomasz-wronki.com.pl](mailto:handel@spomasz-wronki.com.pl)  
[www.spomasz-wronki.com.pl](http://www.spomasz-wronki.com.pl)

### FERRUM PROCESS SYSTEMS (KUNSHAN) CO., LTD.

No. 329, Jujin Road  
Zhangpu Township  
215321 Kunshan City  
Jiangsu Province  
P.R. China  
T +86 512 3662 5403  
F +86 512 3662 5100  
[centrifuge@ferrumChina.com](mailto:centrifuge@ferrumChina.com)

## FURTHER INFORMATION



### CENTRIFUGE TECHNOLOGY

Everything you need to know about your application with our centrifuges.

▶ [ferrum.net/centrifuge](https://ferrum.net/centrifuge)

### SERVICE & ACCESSORIES



▶ [ferrum.net/centrifuge-service](https://ferrum.net/centrifuge-service)

### CONTACT NEW MACHINES



▶ [ferrum.net/centrifuge-contact](https://ferrum.net/centrifuge-contact)